

DESIGN AIR CURTAIN **STAVOKLIMA**

Installation and operation manual

---

# Arcus model





EN



# 1. Table of Contents

- 1. Table of Contents ..... 2
- 2. Unpacking, check after transport or warehousing ..... 3
  - 2.1. Unpacking and check ..... 3
  - 2.2. Storing of the unit, additional transport recommendations ..... 3
  - 2.3. Safety measures ..... 4
- 3. Basic information about the unit and its use ..... 4
- 4. Dimensions of the unit ..... 5
- 5. Mounting of the unit – floor anchoring ..... 6
- 6. Connection of the unit to heating system ..... 8
  - 6.1. Heat exchanger control with a valve with electrothermic head ..... 9
  - 6.2. Setting of independent valve flow pressure (ETVQ) ..... 9
- 7. Ditronic Touch controller ..... 10
- 8. Electric connection of the unit ..... 11
  - 8.1. Unlocking of emergency thermostat for units with the electric heater ..... 11
- 9. Commissioning, starting of the unit ..... 12
- 10. Optional accessories - depending on equipment level ..... 12
- 11. Basic service and maintenance information ..... 12
  - 11.1. Troubleshooting ..... 13
- 12. Cleaning/replacement of the filter ..... 14
- 13. Decommissioning – disposal ..... 15
- 14. Important notes ..... 15

## Explanation of symbols used

 <p>Instructions for mechanical repairs and maintenance.</p>	 <p>Important safety information, technical information, data and device output.</p>
 <p>Important electric information - read carefully - unit damage hazard in case of wrong installation.</p>	 <p>Important information - please read carefully.</p>

## 2. Unpacking, check after transport or warehousing

### 2.1. Unpacking and check

Carefully check the delivery note attached to the delivery. For components identified as extra accessories in the delivery note (not included in the unit or installed therein), please check completeness to the parcel and perfect condition (usually delivered in a separate box). Report any serious damage to packaging or boxes, and make a basic record to the parcel transport documents. Inform the transport company or manufacturer (if the manufacturer arranges transport) immediately.

All packaging material used is environmentally friendly and may be reused or recycled. Dispose of or reprocess the non-environmentally friendly components correctly.

When unpacking, follow the procedure diagrammatically shown below:

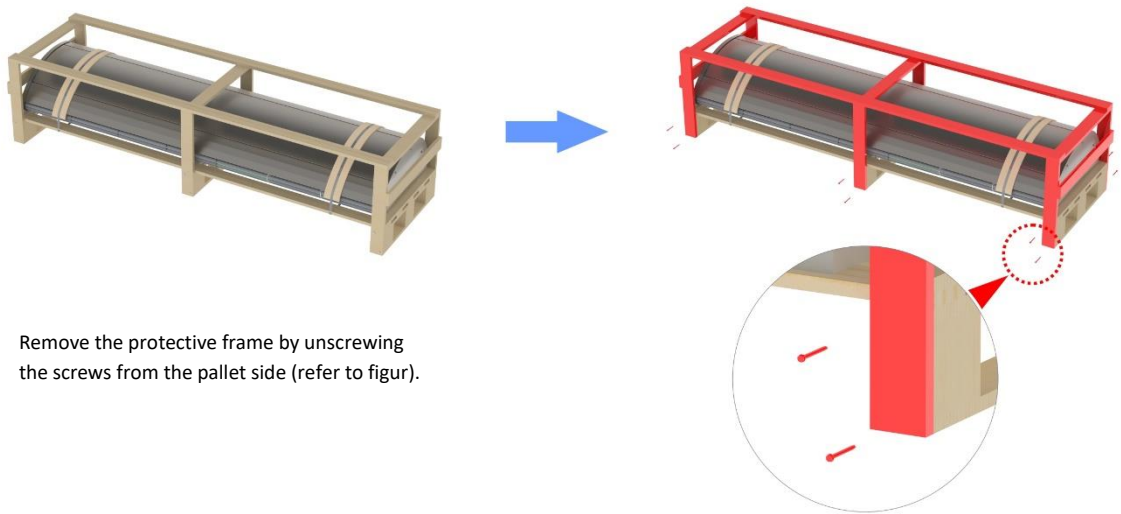

Remove the protective frame by unscrewing the screws from the pallet side (refer to figur).

### 2.2. Storing of the unit, additional transport recommendations



- Observe packaging decals on the unit. The device in its packaging must not be turned or placed in transport positions other than those supplied and recommended by the manufacturer. Packaging also contains production number and unit type for easy unit type identification.
- Use genuine packaging for further transport of the unit. The packaging is tested for re-use, and a different packaging may cause damage to the unit.
- Use means with certified sufficient loading capacity for transport and handling; properly qualified persons only may operate the transport means.
- Permissible warehousing conditions:  $-10^{\circ}\text{C} \div 50^{\circ}\text{C}$ , 50-85% humidity without condensation.
- Do not remove genuine packaging until installation is complete (to avoid device damage). At least 2 persons are recommended for safe handling.



## 2.3. Safety measures

The unit has been manufactured in line with the government decrees and Czech standards harmonized with the EU regulations mentioned in the manufacturer's declaration of conformity.

The above mentioned product complies with the following standards:

ČSN EN 60335-1 ed.3      ČSN EN 60335-2-30 ed. 3  
ČSN EN IEC 61000-6-2 ed. 4      ČSN EN 61000-6-3 ed. 2

The above mentioned product complies with the following directives:

- Directive 2009/125/EC of the European Parliament and of the Council establishing a framework for the setting of eco-design requirements for energy-related products.
- Government Decree No. 118/2016 Coll. Directive 2014/35/EU of the European Parliament and of the Council on the harmonisation of the laws of the Member States relating to the making available on the market of electrical equipment designed for use within certain voltage limits.
- Government Decree No. 117/2016 Coll. Directive 2014/30/EU of the European Parliament and of the Council on the harmonisation of the laws of the Member States relating to electromagnetic compatibility.
- Government Decree No. 481/2012 Coll. (Regulation of the European Parliament and of the Council No. 2014/35/EU, Regulation of the European Parliament and of the Council No. 2011/65/EU).
- Government Decree on restriction the use of some hazardous materials found in electrical and electronic products.

Observe generally applicable national provisions and other related regulations. Unplug the unit from mains before any service intervention. Connection and earthing of the electric device or components thereof must be in line with laws applicable in the country of use. Only qualified staff may carry out any electric service works.



Observe applicable laws, in particular:

- on safety of electric and thermal appliances,
- on central heat distribution systems,
- on fire safety,
- do never exceed working pressure and temperature specified in the production label.

Follow standards and rules applicable in the country of use, in particular the fire safety of appliances and heat sources, and the fire technical properties of materials - flammability levels. Place the unit 150mm from B, C1, C2 level flammable materials, and 400mm and 1000mm for C3 level easily flammable materials in the radiation direction (air flow from the unit).

## 3. Basic information about the unit and its use

An air unit is a device, which produces a natural air barrier against penetration of cold air into heat environment (in summer, it operates as a protection against penetration of hot summer air to the spaces being either cooled or air conditioned). These devices are suitable for basic and non-aggressive environment. The permitted temperature range in the space is 5–40 °C.

For the curtaining purposes, either circulation air of the environment temperature or the circulation air heated by hot-water or electric heater may be used. The use of the device can save high cooling costs in the air conditioned spaces. Full performance of the unit may be provided only when maintenance is regular and proper. All controls are accessible and well maintained.

Technical conditions for unit operation:



- max. media working temperature 90°C/pressure 1.6MPa – unless specified otherwise,
- hot water working voltage – 230V/50Hz, electric heater unit working voltage - 400V/50Hz,
- max. surrounding temperature 40°C,
- IP rating of hot water unit - IP 20/IP rating of electric heater unit - IP 20,
- the unit is intended for basic and non-aggressive environment,
- the hot water units are equipped with a filter - use only the filters supplied by the manufacturer!
- minimum pressure difference 23kPa must be provided for use of a 2W valve (applies only to a pressure-independent valve).

4. Dimensions of the unit

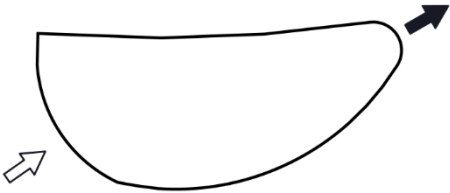
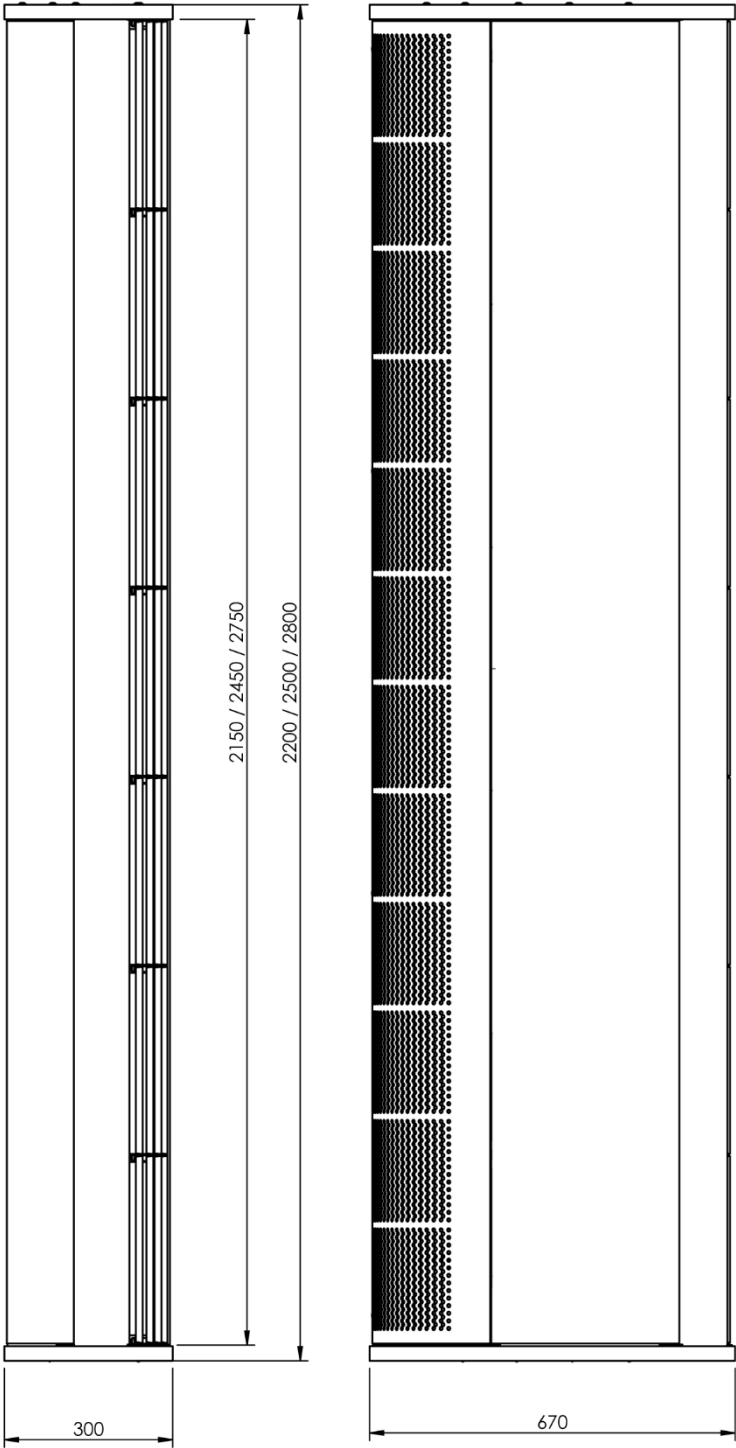

## 5. Mounting of the unit – floor anchoring

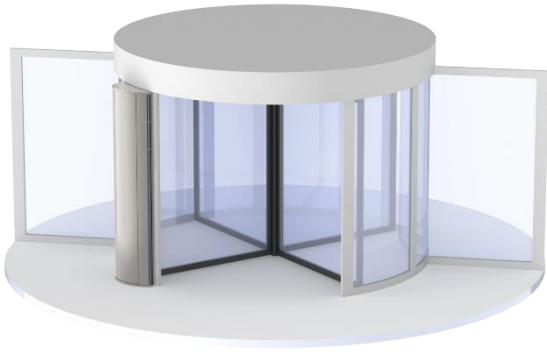

Installation on the left from the door

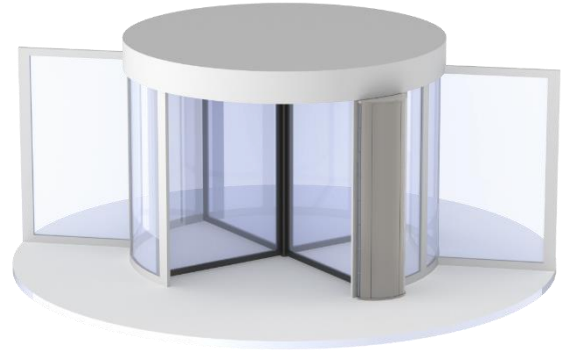

Installation on the right from the door

The door Arcus unit is designed as a vertical unit with media connection (heating medium and electric connection) of the lower portion of the unit (unless ordered otherwise). The bottom part of the unit consists of the foundation anchor plate (inner side wall and bottom side wall). Upon delivery, these components may be bolted each other from the factory. Prior to assembly, unscrew the bottom side wall using a key. The inner side wall is accessible after the suction grid and revision lid are open.



Open the unit as follows:

1. Remove plastic plugs from the suction grid.
2. Use the Allen wrench to lose the bolts that lock the grid.
3. Open the grid.
4. Then, use the Allen wrench to lose the bolts that lock the revision lid. The bolts are located inside the unit on the suction grid hinges side.
5. Open the revision lid.

During installation, proceed carefully to avoid personal injury or unit damage due to fall.

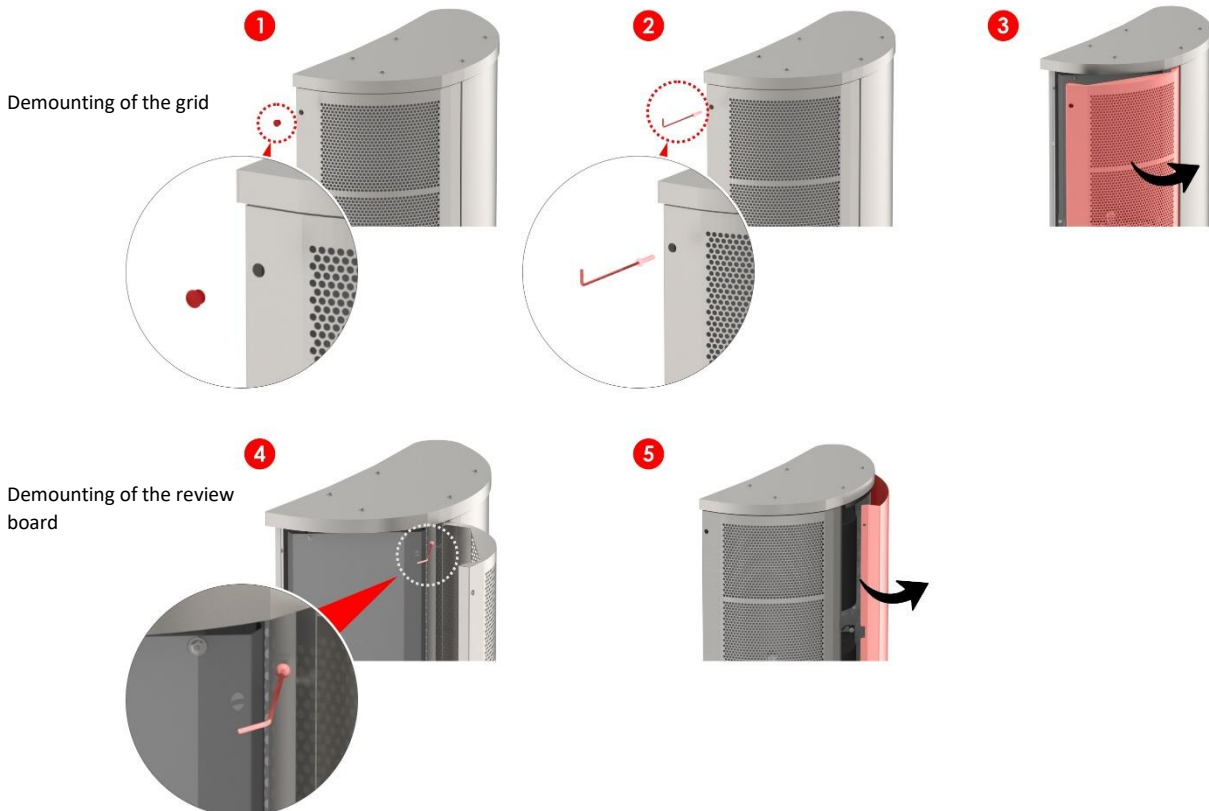



## 6. Connection of the unit to heating system



Please check all hot water connections for readiness and perfect condition before connecting media to the unit. Furthermore, please check the hot distribution for components or other measures to ensure zero transmission of static, dynamic, and dilatation forces at the input and output neck connections. No excessive force may be applied when connecting the hot water circuit of the building to the unit's heat exchanger. By the neck of the air conditioner there is a mark that notes use of two keys so that no stressing of the necks occurs in the course of tightening or loosening. **When bolting and tightening up the screw union of the heat exchanger must be secured by a clamp against undesired rotation that may subsequently result in deformations or damage to pipe necks on the heat exchanger.**

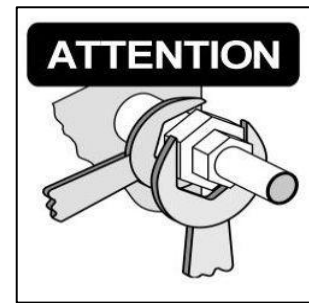

Any non-compliance with the instructions above results in rejection of any complaint.

By default, neck for the hot water heater is located on the lower portion on the upper part of the unit (may be placed elsewhere upon request). They are usually terminated by ball valves. The inputs are identified by round marks – **medium input red** with arrow pointing inside, and **medium output blue** with arrow pointing outside.

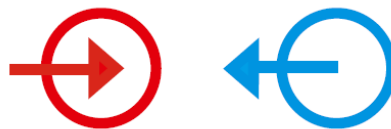

Media input

Media output



Illustrative connection of sockets



Do not swap the return and supply neck positions - this may cardinaly change performance and parameters of the heater with consequent impact on the hydraulic system. Do not exceed max temperature and pressure for which the unit is rated.

The necks for media connection must be prepared and mounted in full conformity with the illustrated drawing. Do not forget to mount closures of both media directions (unless included in the supply).

If required, the valve may be embedded in the unit. Some types of the valves may not be placed in the unit for room reasons (located outside the equipment). The function of the electrothermic valve drive is given by a control type. The connection is then made directly on the neck for media input (third neck is blind). For electrothermic drive functions, refer to clause 6.1.

Pay attention to quality of media fed to the unit; check for installation of cleaning valve downstream the unit (not included in the supply). Observe max temperature and media pressure to avoid heat exchanger damage. To make sure the heat exchanger operates correctly, drain the exchanger (sludge valve) and purge the cleaning valve because construction or assembly impurities may be present in the system. Deaerate the heat exchanger for perfect operation of the heat exchanger. The deaeration valves are located in the upper portion of the heat exchanger and may be accessed after the suction grid is open (refer to figure). When deaerating or filling the heat exchanger with medium, first close the return pipeline closure, then open the deaerating valve, and release the closure to fill in the heat exchanger.

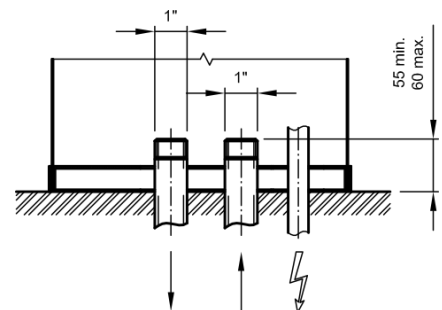

Deaeration valves

As required by the customer, an embedded 2-way valve with control head can be delivered for the hot water heat exchanger. The valve drive is electrothermic. Instructions for electric connection of the valve is included in the wiring scheme for connection of the unit. Specific wiring scheme or valve instructions are available upon request only.

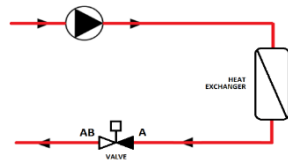

Connection of 2-way ETVQ valve

## 6.1. Heat exchanger control with a valve with electrothermic head

The electrothermic valve drive can be supplied to the hot water heat exchanger as embedded as 2-way (ETVQ).

“Normally open” version (NO)

When the thermal drive is under voltage, the electrically heated sensor heats up. Upon “dead time” expiration for continuous opening of thermic drive due to cooling down of the sensor.

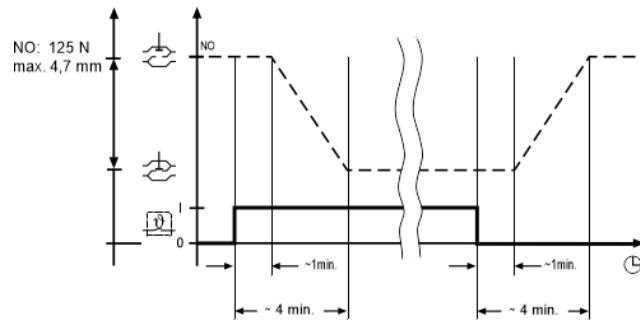
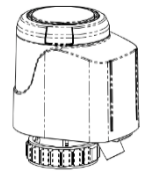

Note:

The time delay (dead time) needs to be considered during the functional test; the opening and closing time depends on surrounding temperature. Electric data: 230V/50Hz-3V, IP 54.

## 6.2. Setting of independent valve flow pressure (ETVQ)

**Setup**

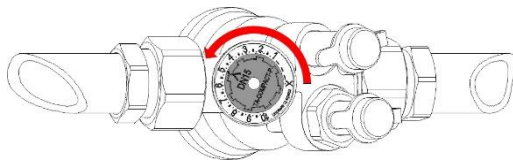

Turn the setting wheel to required value, e.g., 5.0.

**Closing**

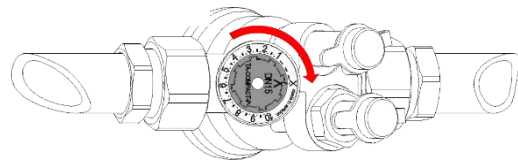

Turn the setting wheel counterclockwise to position X.

**q<sub>max</sub> values**

**Setup**

	1	2	3	4	5	6	7	8	9	10
DN 25	370	610	830	1050	1270	1490	1720	1870	2050	2150
DN 32	800	1220	1620	2060	2450	2790	3080	3350	3550	3700

q<sub>max</sub> = l/h for each setting with the control cone fully open

## 7. Ditronic Touch controller



The Ditronic Touch controller is highly comfortable controller for fan and heater control (hot water heater and electric one) with optional connection of external elements (door contact, BMS, etc.). Controller function is defined by type of the electric documentation. The controller is designed for wall-mounted installation and a separate instructions manual is available. Included to the controller is the Ni-1000 room sensor to be connected to the control board according to the electric wiring documentation.

The hot water unit has a Ditronic control board located at the top. The non-heated and electrically heated unit has a Ditronic control board located at the bottom.

The connection between the air curtain and the controller is made using a UTP cable with RJ 45 connector (available as optional accessories in various lengths).

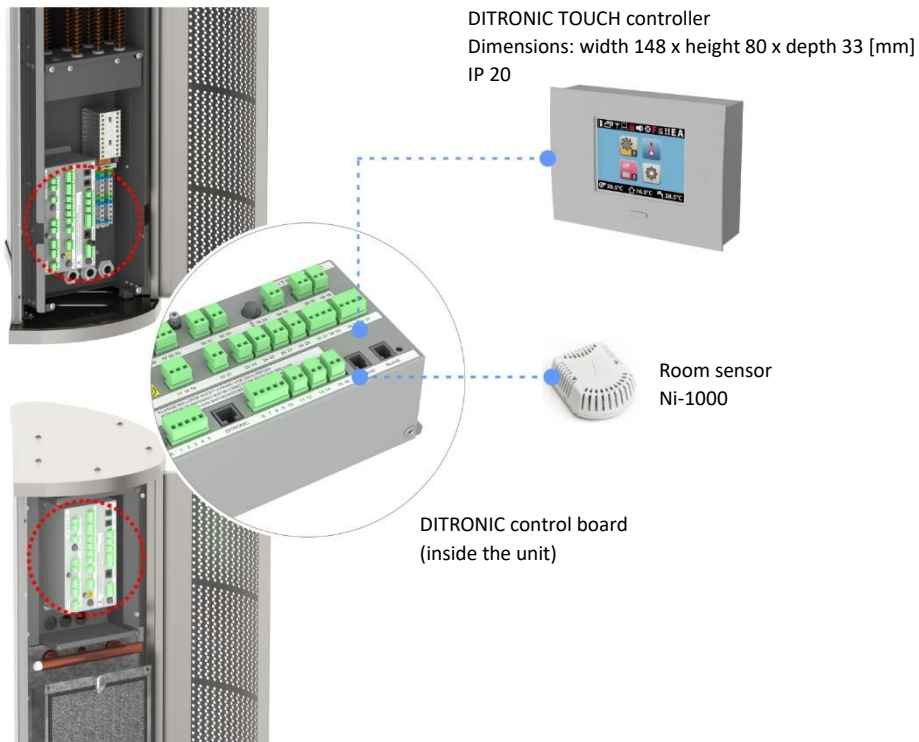

## 8. Electric connection of the unit



The unit must be protected by a suitable circuit breaker according to its electric parameters – refer to attached electric wiring. Connect the ready-to-install cables to the terminals following the attached electric wiring schemes, make connection check, equipotential bonding, and finally turn the power supply on. Use the cable wires with cross section suitably rated according to the current load – refer to electric wiring documentation.

When connecting the electric installation, it is necessary to open the suction grid and unscrew the box lid with a Phillips screwdriver.

Make sure the cable is neither twisted nor deformed in any way. Keep free ends of the cable wires sufficiently long for easy handling (for the hot water unit, the cables run up to the upper portion) and cut the wire only after you are sure the wire is long enough.

Observe generally applicable national provisions, particularly ČSN 12 2002 and other related regulations. Unplug the unit from mains before any service intervention. Provisions of ČSN 332190, 332000-5-51 ed. 3, and 33 2000-5-54 ed. 3 must be observed for connecting and earthing of the electric devices. Qualified electrician only may perform any electric service works (qualification according to Section 6 of Decree of ČBU No. 50/78 Coll.).



Depiction of cable orifice for the unit fitted with electric heater



During assembly, carefully check everything and carry out the initial review of the device. Check operation of the FU1-FU3 electric fuses (Ditronic) for interior circuits (for fuse values, refer to the box of electronics), and make sure that the external components (accessories), which may have an essential impact on correct function of the device, operate.

**ATTENTION: The delivery note serves as a warranty sheet!**

### 8.1. Unlocking of emergency thermostat for units with the electric heater



**The units fitted with the electric heater** are provided with operation thermostat with automatic reset feature (located on each heater) and emergency thermostat with manual reset.

When permitted limit temperature inside the unit is exceeded, heating circuit is turned off by the emergency thermostat = pushbutton sprung up. The button is used to unlock the safety thermostat in case of the device failure. After cooling down the thermostat button needs to be pressed back to default position. (refer to figure).



**ATTENTION – unblocking of the emergency thermostat does not resolve failure of the unit! Always remedy the cause of the thermostat overheating!!!**

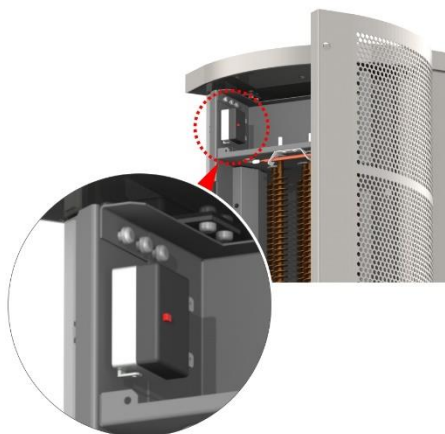

Covering of the air curtain with any strange objects is prohibited ► risk of fire!!!

## 9. Commissioning, starting of the unit

Before commissioning make and check:

- covers and shell of the unit are in perfect condition,
- mechanic fixing and anchoring of the unit,
- ability to remove the filter and its cleanliness,\*/\*\*
- fixing of thermostatic head and its setting,\*/\*\*
- function of circulating pump (not included in the device),\*\*
- correct connection of media and tight connections,\*\*
- tightness and function of the valves,\*/\*\*
- availability of power voltage,
- correct connection of all unit cables,
- fitting and setting of a pre-circuit breaker (not included in the device),
- free from mechanical impurities or objects.

\* if installed

\*\* hot-water version only

Initial review of the electric appliance according to ČSN 331500 and ČSN 33 2000-6-61 ed. 2 must be made upon commissioning.

## 10. Optional accessories - depending on equipment level



The most frequent accessories include electrothermic valves for the temperature control (chapter 6.1). The valves are usually embedded by the manufacturer, for all available valve types refer to the catalogue.

Another accessory used is the door contact (either magnetic or mechanic). The contacts are placed on the door wings or door parts in order to signal the position of the door.

An optional accessories may be e.g., room thermostat, hanging of the unit, 0–10V signal control of the unit over the superior BMS, and more. Selection of an appropriate type of accessories must be supported by the controller type.

For all accessories offered for the Arcus unit, refer to the catalogue documentation.

## 11. Basic service and maintenance information



All units are thoroughly checked and tested by the manufacturer before dispatch. The most frequent errors root from misunderstanding of the unit function or incorrect cabling and connection. For this, observe instructions from the manufacturer to avoid complex troubleshooting. In no case try to operate the unit when connected in a different way - the unit may operate for a while as you wish or expect but this irreversible step may result in damage beyond repair and loss. No warranty claims can be accepted with respect to this damage.

The Arcus air units are made of quality materials that require no special maintenance. However, we recommend that maintenance in required or shorter (depending on your observations due to operation in a specific application) intervals is carried out for long lifecycle of the unit.



**Before any work with the unit, disconnect the electric power supply, mains supply for the unit. Electric shock hazard !!!**

Observe generally applicable national provisions, particularly ČSN 12 2002 and other related regulations. Unplug the unit from mains before any service intervention. Provisions of ČSN 332190, 332000-5-51 ed. 3, and 33 2000-5-54 ed. 3 must be observed for connecting and earthing of the electric devices. Qualified electrician only may perform any electric service works (qualification according to Decree of ČBU No. 50/78 Coll., § 6 is required).

Please contact your vendor or distributor for a service agreement. You will get regular service and excellent care of your unit.



## Quarterly checks:

- Unit positioning and tightening of all bolt connections. Then, check tightening of bolts of exhaust splines.
- Heat exchanger space check and remove dirt or foreign objects (use vacuum cleaner for dedusting, or steam for stuck dirt). When using steam for removal of dirt, always proceed downstream the air flow. Set as lowest temperature as possible and as lowest steam pressure as possible for not to damage the heat exchanger by cleaning (remove filter before cleaning – filter damage hazard).\*
- Check cleanliness of the motor body and inner or outer parts of the unit. Do not wash the motor body with water! Wipe with lukewarm towel only – motor winding damage hazard; after the motor is cleaned, do not turn the unit on for 60 minutes – let it dry properly. Proceed carefully when wiping of the exhaust splines - fragile splines - danger of damage!
- Before winter, check in particular the anti-frost protection function (if installed), superior circulating pump (not included in the supply of the device), setting of thermostatic or electrothermic valve.\*
- Re-test tightness of the unit or of installed fittings on the water side. If a sludge filter is installed before the unit – clean the filter and check deaeration of the heat exchanger.
- Check unit safety with respect to electric shock hazard according to applicable ČSN or national standards, including earthing inspection.
- Thorough cleaning of the suction grid, exhaust splines (tighten up, if necessary).

\* if installed

## 11.1. Troubleshooting

Problem	Possible cause	Remedy
The unit can not be turned on	Unit circuit-breaker is off	Turn on
	Mains failure	Inspection
	Fuse in the unit	Inspection
	Door contact	Check connection or interconnection
	Anti-frost protection	Inspection
	Controller position "0"	Check, > position than "0"
	External contact	Check connection or interconnection
Noisy motor	Defective motor mount	Check - replacement
	Clogged filter*	Check - replacement
Motor overheats (motor thermal contact turns off)	Defective motor mount or winding	Replace fan or motor unit
	Clogged filter*	Check, clean
	Heavily soiled motor – insufficient cooling	Check, clean
	Excessive temperature of intake air	Inspection
	Excessive temperature of intake medium	Check setup, remove
The fan delivers little air only	Clogged filter*	Check - replacement
	Soiled heat exchanger	Check - replacement
Unit is not heating	Broken or clogged medium supply	Check - replacement
	Little air flows through the heat exchanger	Check - remove
	Soiled heat exchanger splines	Remove
	Insufficient media temperature	Remove
	Medium does not circulate	Check, deaerate
	Temperature achieved in line with controller setup	Controller setup
	Defective drive of electrothermic valve	Check setup, or replace if defective
	Overheated motor	Find out and clear the cause
Automatic operation disconnection	Door contact	Check correct function (refer to controller description)
	External clock	Check correct function (refer to controller description)

\* if installed

## 12. Cleaning/replacement of the filter



Hot-water units are fitted with an air filter. The filter must be cleaned regularly to ensure the efficiency of the unit and its performance levels. The frequency of cleaning depends on local conditions under which the unit operates – checking of the filter and cleaning thereof is recommended at least monthly. Clogged filter does not stand for a safety risk but operation of the unit may deteriorate.

Filter removal:

- 1-3) Use the Allen wrench to lose the bolts that lock the grid, if released.
- 4) Release the filter from the unit by rotating the locks on the filter sides.
- 5) Remove the filter and get rid of the dust particles. Replace the filter if the clogging is still apparent despite thorough cleaning, or if the fabric is mechanically damaged.

A spare filter can be ordered as optional accessory in the set of 3 pieces. Use genuine filters only. **Use of a filter other than the one approved by the manufacturer is prohibited.**

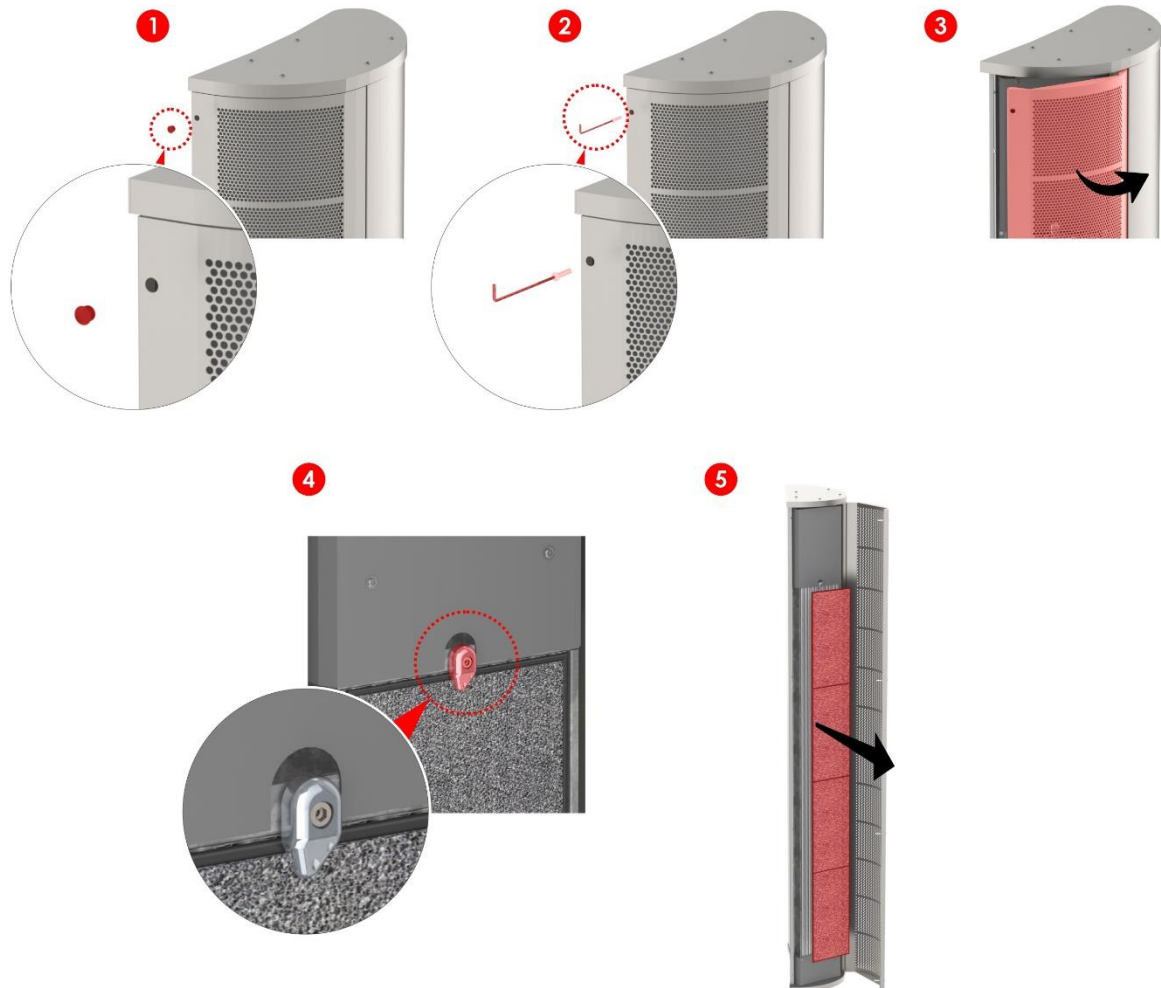

## 13. Decommissioning – disposal



After the expiration of the service life, the unit must be disassembled and disposed of. Only qualified company may disassemble the device. The product or components thereof must be disposed in environmentally-friendly manner at the end of its service life.

The components of the unit must be separated and sorted out by type of material for disposal. Dispose of the metal and plastic components at your local collection yard. The transport packaging of the product is made of common recyclable material (paper, polyethylene, wood) and is labelled as such according to ČSN 77 0052-2.

As far as disposal is concerned, it is operator's responsibility to comply with applicable national provisions in the country of use. In addition, follow regulations and laws of your country applicable to waste disposal. Separated collection and recycling of the products may help to protect environment and human health.

## 14. Important notes



The door units are intended to avoid heat or cold loss, filtration, and heating, or for ventilation in combination with mixing accessories. Other uses are not intended. The manufacturer accepts no liability for damage resulting from use other than intended. Observe this manual in operation of the units.

Installation, electric connection, and repairs must be carried out by qualified persons according to § 6 of Decree No. 50/78 Coll. or according to applicable national standards and regulations. An expert company is needed to connect the heating medium.

Before the start of the heating season, it is necessary to provide the required amount of heating medium with the design values for units with the hot water heater.

**The manufacturer reserves right to changes for marketing or production reasons without prior notice!**



**STAVOKLIMA s.r.o.**  
Budějovická 450, 370 01 Homole  
Tel.: +420 387 001 931  
e-mail: [info@stavoklima.cz](mailto:info@stavoklima.cz)  
[www.stavoklima.cz](http://www.stavoklima.cz)

